

For xmi mineral insulated (mi) heating cables

PRODUCT OVERVIEW

XMI with standard MI cold lead and Type X connector

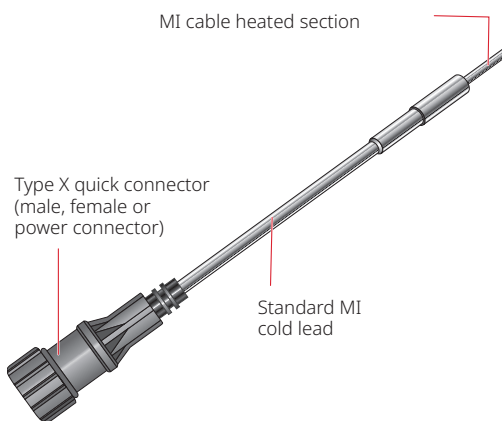

Raychem XMI mineral insulated cold lead cables can be supplied with optional Type X quick connectors. The connector is a “plug-in” style used to make quick and easy connections to other XMI heating cables in series, or to connect to a cable supplying power to the XMI heating cable.

FEATURES

- Easy installation in the field without the need for a junction box
- Reduced labor costs in the field as wiring of junction box is eliminated for splice connections
- Coaxial type connector means no rotational alignment of connectors on cold leads is required
- Quick connection and disconnection of cold leads and power connections in the field results in reduced maintenance costs
- Ideal for applications in module yards where series connected heating cables will be joined at module breaks

PRODUCT OVERVIEW

XMI with PyroFLX cold lead and Type K connector

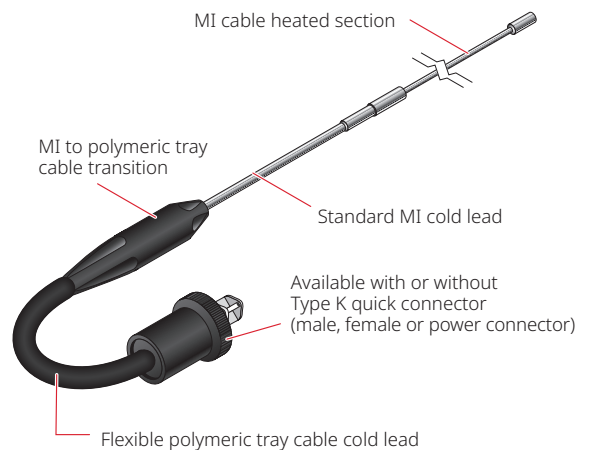

Raychem XMI mineral insulated cold lead cables are also available with an optional flexible polymeric PyroFLX cold lead with or without quick connectors. The PyroFLX cold lead option offers all of the benefits of a metal sheathed, Alloy 825 MI heating cable, along with the added advantages of a flexible, easy-to-install cold lead section.

The PyroFLX cold lead consists of a section of cold weather capable, highly impact resistant, flexible polymeric Type TC tray cable, integrated to a short segment of standard MI cold lead.

FEATURES

- Installations using the PyroFLX cold lead can be performed without excessive cold lead shaping and forming, minimizing expensive on-site labor costs, especially when long cold leads are required.
- The cable can be easily routed in the field and junction boxes and cable-to-cable connections can be extended to make them easily accessible for maintenance purposes, avoiding costly scaffolding and maintenance troubleshooting time.
- Ideal for applications in module yards where series connected heating cables will be joined at module breaks, around high maintenance valves to allow quick disconnection, and when re-locating the heating cable junction box down to grade level from a high point on a pipe rack.

This data sheet must be used in conjunction with the XMI-A data sheet H56870 and the XMI-L data sheet H59079. For additional information on other optional connectors that are available for MI cold leads, contact your Chemelex representative or call (800) 545-6258.

APPROVALS - TYPE X QUICK CONNECTORS

XMI with type X quick connector

Nonhazardous and Hazardous Locations



Class I Div 2 (Zone 2) Groups A, B, C and D

TYPE X QUICK CONNECTOR SPECIFICATIONS

Voltage Rating	600 V
Current Rating	35 A
Connector Rating	Type 6, IP 67
Temperature Rating (ambient)	-40°F to 122°F (-40°C to 50°C)
Connector Length	
Male	5 in (127 mm)
Female	5 in (127 mm)
Connector Insert Color	
Male	Black
Female	Blue

Type X Male connector

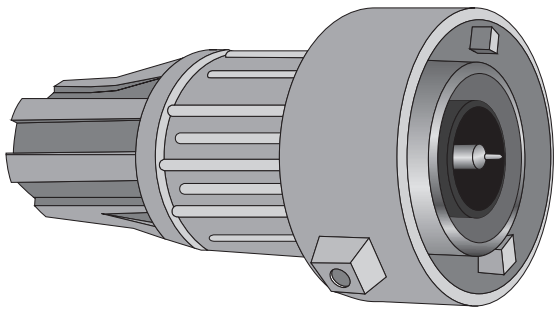

Type X Female connector

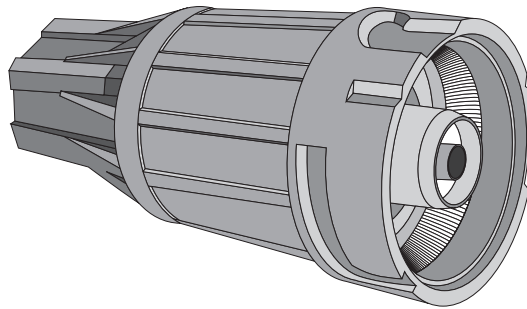

BASIC HEATING CABLE DESIGN CONFIGURATIONS WITH TYPE X QUICK CONNECTOR

XMI mineral insulated heating cables can be supplied with Type X quick connectors in the four basic design configurations shown below. Design configurations A and D are supplied from the factory with one or more quick connectors assembled to the cold lead. Configurations B and E can be supplied with a combination of connectors or with a connector on one end and no connector on the other end.

Type X quick connectors for conventional MI cold leads are available in a combination of male, female, or power connector options (power connectors consist of a female and a male connector on a cold lead cable).

Design A (Single conductor)

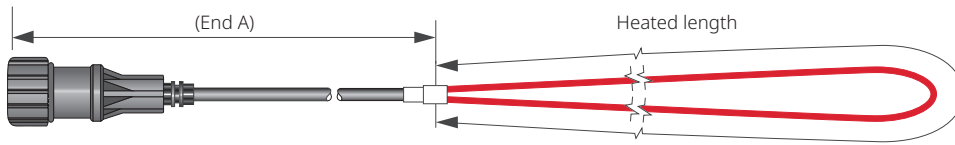

Design B (Single conductor)

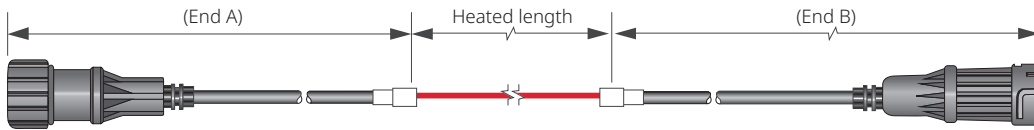

Design D (Dual conductor)

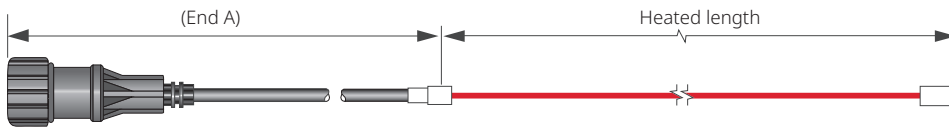

Design E (Dual conductor)

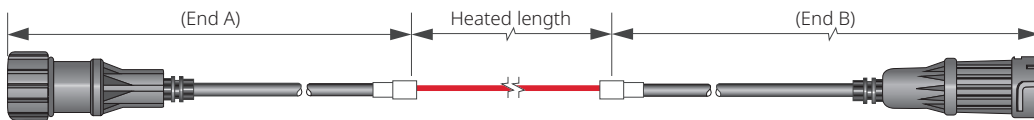

HEATING CABLE CATALOG NUMBER WITH TYPE X QUICK CONNECTOR

An XMI heating unit with Type X connectors is ordered by compiling the catalog number based on the design of the specific engineered heating unit required for your application. Typically, an engineered heating unit is designed using our TraceCalc Pro design software which provides the catalog number as part of the design output. An explanation of the catalog number follows:

Example: Engineered Heating Unit (Part No.: GEHU)

GEHU: E/32SA2200/40/538/208/5-7/S25A/X/N12/XMF

E / 32SA2200 / 40 / 538 / 208 / 5 - 7 / S25A / X / N12 / XMF

Position: 1 / 2 / 3 / 4 / 5 / 6 / 7 / 8 / 9 / 10

Position	Characteristic	Code options	Description
1	Design Configuration ¹	A, B, D, or E	Designates the basic heating cable design configuration of the XMI engineered heating unit (XMI-L units available only in D and E configurations).
2	Heating cable reference	See XMI-A and XMI-L data sheets	Indicates the XMI-A or XMI-L heating cable reference used in the design. Refer to data sheets H56870 and H59079.
3	Heated length	Length of the heated section in feet or meters	Default value is in feet; if in meters add "M" after the length.
4	Power	Power output of the heating unit	Power output at maintain temperature, in Watts, for the total heated length of the engineered heating unit.
5	Voltage	Effective voltage applied to a heating unit	This is the designed effective voltage that will be applied to the engineered heating unit (in the case of series connected heating units, it is the voltage across a single unit).
6	MI cold lead length	Length of the MI cold lead in feet or meters (End A length) or (End A length)- (End B length)	Default value is in feet; if in meters add "M" after the length. Standard lengths for XMI engineered heating units are 4 feet (1.2 m) or 7 feet (2.1 m), however, custom lengths can be designated here. For E and B configurations, which have cold leads on each end, a single value (such as "7") indicates that the MI cold lead on both ends is 7 feet long. A hyphenated value (such as "5-7") indicates that the cold lead on one end (End A) is 5 feet long and the cold lead on the other end (End B) is 7 feet long. Note that when specifying quick connectors for E and B configurations with two different cold lead lengths (such as "5-7"), the first number (5) is the length for End A and the second number (7) is the length for End B. This nomenclature ensures that the correct connector is installed on the correct length of cold lead.
7	MI cold lead code	Select the cold lead code from Table 1	Table 1 is used to select the appropriate MI cold lead based on the current and voltage rating required by the design.
8	Hot-cold joint type	X or C	"X" type joint is used with all XMI-A engineered heating units. "C" type joint is used with all XMI-L engineered heating units.
9	Gland size reference	Refer to Table 1	Gland size depends on the cold lead code selected from Table 1.
10	Connector options ²		Position 10 in the EHU catalog number consists of three letters. The first letter (X) indicates Type X connector; the second letter (M, P, or N) is the connector option for End A and the third letter (M, F, or N) is the connector option for End B.
		XMN - Male/Nothing	Standard MI cold lead with a Male connector on End A and no connector on End B.
		XNF - Nothing/Female	Standard MI cold lead with no connector on End A and a Female connector on End B.
		XMF - Male/Female	Standard MI cold lead with a Male connector on End A and a Female connector on End B.
		XPF - Power/Female	Standard MI cold lead with a Power connector on End A and a Female connector on End B.
		XPN - Power/Nothing	Standard MI cold lead with a Power connector on End A and no connector on End B.
		XMM - Male/Male	Standard MI cold lead with a Male connector on End A and a Male connector on End B.

1 Since Design A and Design D units only have a single cold lead, End B will always be "Nothing" (i.e. no connector).

2 A Power connector consists of both a Female and a Male connector (the Male connector is attached to the cold lead; the Female connector will

be connected to the power supply at the job site).

HEATING UNIT OPTIONS USING TYPE X QUICK CONNECTOR

Design A (Single conductor)

Design D (Dual conductor)

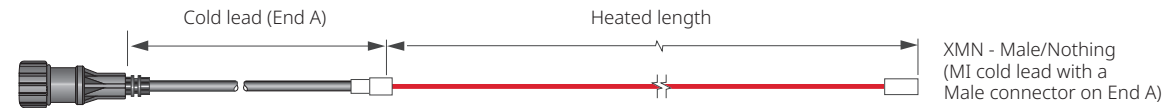

Note: D design configuration shown

Design B (Single conductor)

Design E (Dual conductor)

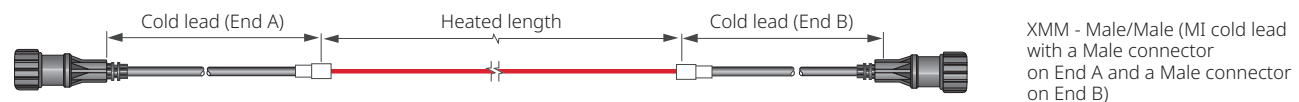
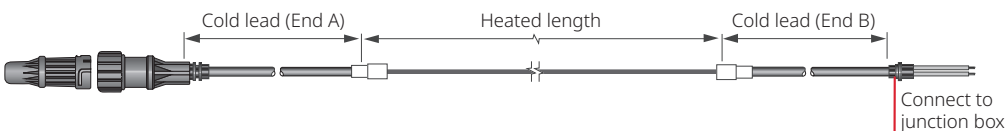
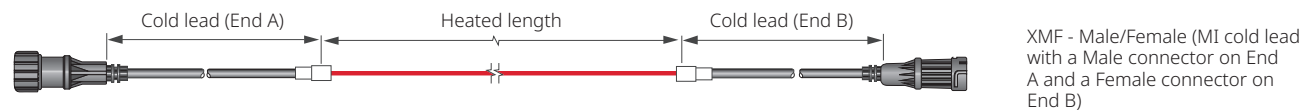
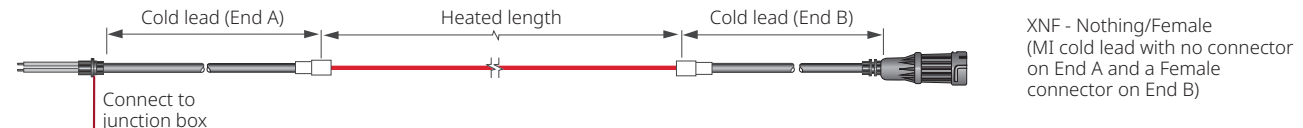
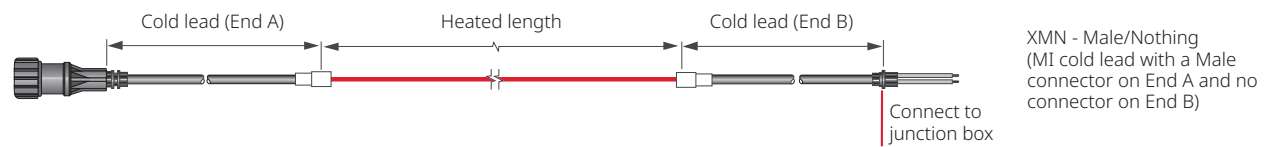

Note: E design configuration shown

EXAMPLES USING TYPE X QUICK CONNECTORS

D/62SQ3100/200/9920/480/4/S25A/X/N12/XMN

- Configuration is Design D
- XMI-A62 heating cable (600 V rated, dual conductor cable), resistance at 20°C is 0.100 Ω/ft (0.328 Ω/m)
- Heating cable length is 200 ft (61 m)
- Heating cable wattage is 9920 W at 480 V
- MI cold lead length is 4 ft (1.2 m) on End A
- MI cold lead code is S25A (25 Amps)
- Hot-cold joint type is "X" for use with XMI-A Alloy 825 sheath cables
- Gland connector is ½ in NPT
- Type X Male connector on End A

B/61SQ3118/250/6820/480/5-7/S29A/X/N12/XMF

- Configuration is Design B
- XMI-A61 heating cable (600 V rated, single conductor cable), resistance at 20°C is 0.118 Ω/ft (0.387 Ω/m)
- Heating cable length is 250 ft (76 m)
- Heating cable wattage is 6820 W at 480 V
- MI cold lead length is 5 ft (1.5 m) on End A and 7 ft (2.1 m) on End B
- MI cold lead code is S29A (29 Amps)
- Hot-cold joint type is "X" for use with XMI-A Alloy 825 sheath cables
- Gland connector is ½ in NPT
- Type X Male connector on End A and Female connector on End B

E/32SQ3200/25M/870/120/2.1M/LS23A/X/N12/XPF

- Configuration is Design E
- XMI-A32 heating cable (300 V rated, dual conductor cable), resistance at 20°C is 0.200 Ω/ft (0.656 Ω/m)
- Heating cable length is 25 m (82 ft)
- Heating cable wattage is 870 W at 120 V
- MI cold lead length is 2.1 m (7 ft) on both End A and End B
- MI cold lead code is LS23A (23 Amps)
- Hot-cold joint type is "X" for use with XMI-A Alloy 825 sheath cables
- Gland connector is ½ in NPT
- Type X Power connector on End A and Female connector on End B

TABLE 1 MI COLD LEAD SELECTION FOR USE WITH TYPE X QUICK CONNECTORS

Due to current rating limitations, only the standard cold leads shown in Table 1 may be used with Type X connectors. The cold lead is supplied from the factory with one or more quick connectors assembled to the cold lead.

Cold lead code	Maximum voltage (V)	Maximum current (A)	Cold lead diameter		Gland size (NPT) ³	Gland size reference	Tail size (AWG) ⁴
			(in)	(mm)			
Design A, D, E							
LS23A	300	23	0.319	8.1	½ in	N12	14
S25A	600	25	0.355	9.0	½ in	N12	14
S34A	600	34	0.402	10.2	¾ in	N34	10
S49A	600	35	0.496	12.6	¾ in	N34	8
Design B							
S29A	600	29	0.215	5.5	½ in	N12	12
S48A	600	35	0.253	6.4	½ in	N12	8

Note: MI cold lead minimum bending radius is 6 times the cable diameter.

³ NPT gland will be factory-assembled to the quick connector and not visible. If a quick connector is not supplied on one end of a Design B or E unit, the cold lead will be terminated with the standard NPT gland connector.

⁴ Tail size applies to cold leads without quick connectors

PYROFLX COLD LEAD OPTIONS

Heating cables with the PyroFLX cold lead option are supplied as complete factory-fabricated assemblies consisting of a MI heated section joined to a short segment of MI nonheating cold lead, which transitions into a flexible, polymeric tray cable by means of a molded splice.

There are three options for connection configurations on the PyroFLX cold lead.

1) No connector

- PyroFLX cold lead only for attachment into junction box
- Customer must supply approved junction box connector for Type TC tray cable

2) Factory installed Type K quick connector

- Installed standard at the factory (can be replaced in the field)
- Available in both male, female, and power configurations

3) Field-installed Type K quick connector

- Mechanically attached to PyroFLX cold lead cable in the field
- Available in both male, female, and power configurations

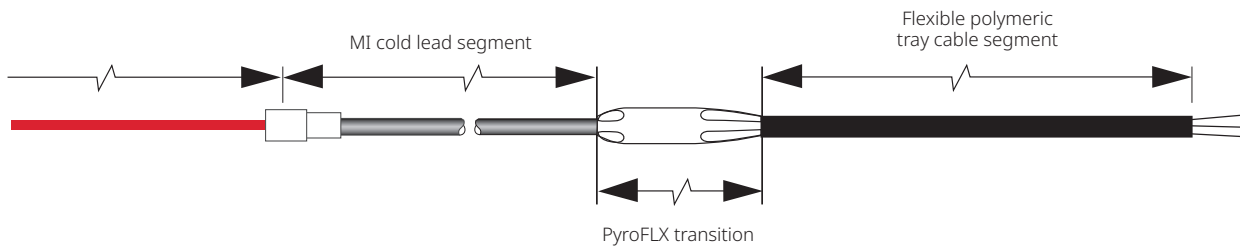

APPROVALS - PYROFLX COLD LEAD AND TYPE K QUICK CONNECTORS

XMI with Pyroflx and optional Type K Quick Connectors Nonhazardous and Hazardous Locations



Class I Div 2 (Zone 2) Groups A, B, C and D

Note: Not approved for USA.

PYROFLX COLD LEAD AND TYPE K QUICK CONNECTOR SPECIFICATIONS

Voltage Rating	600 V
Current Rating	30 A

Standard PyroFLX Cold Lead

MI Cold Lead Segment ⁵	5 ft (1.5 m)
Flexible Tray Cable Segment ⁵	3 ft (0.9 m)
Flexible Tray Cable Diameter	0.56 in (14.2 mm)
Flexible Tray Cable AWG Size	10 AWG
Flexible Tray Cable Bending Radius	2.2 in (56 mm)
Flexible Tray Cable Maximum Exposure Temperature	194°F (90°C)
Connector Rating	Type 6P, IP 65 ... IP 68
Temperature Rating (ambient)	-40°F to 140°F (-40°C to 60°C)

Connector Length

Male	3.2 in (81 mm)
Female	2.8 in (70 mm)

Connector Insert Color

Male	Black
Female	Light gray

⁵ Longer lengths available

Type K Male connector

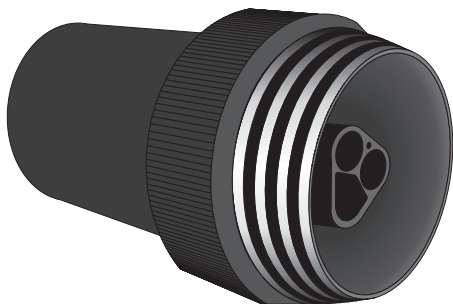

Type K Female connector

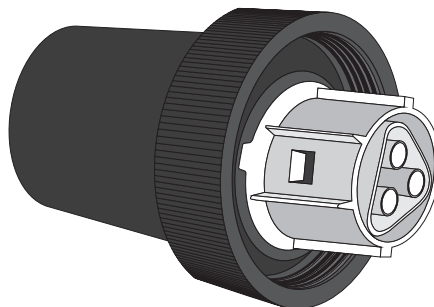

BASIC HEATING CABLE DESIGN CONFIGURATIONS WITH PYROFLX COLD LEAD AND TYPE K CONNECTOR

XMI mineral insulated heating cables can be supplied with PyroFLX cold leads with or without Type K quick connectors. They are available in the four basic design configurations shown below. PyroFLX cold leads, for all design configurations, can be supplied with optional factory-installed Type K quick-connectors which do not require a junction box, or without a connector for field routing, trimming and installation into a junction box using standard tray cable connectors.

Type K quick connectors for PyroFLX cold leads are available in a combination of male, female, or power connector options (power connectors consist of a female and a male connector on one end of the heating cable).

Design A (Single conductor)

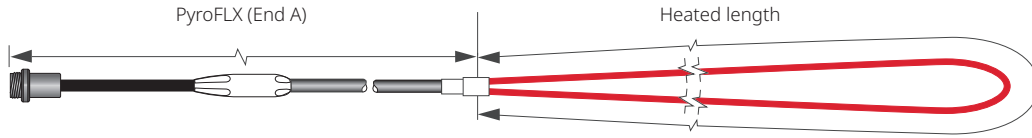

Design B (Single conductor)

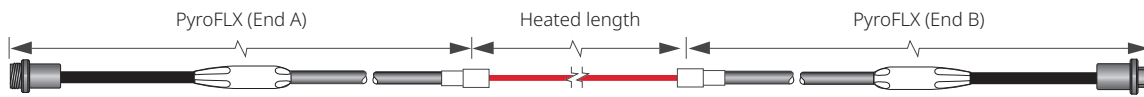

Design D (Dual conductor)

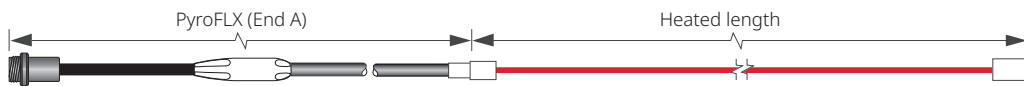

Design E (Dual conductor)

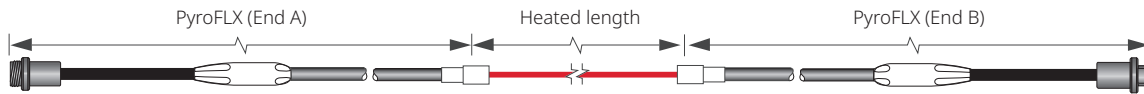

HEATING CABLE CATALOG NUMBER WITH PYROFLX COLD LEAD

An XMI heating unit with PyroFLX cold leads, with or without Type K connectors, is ordered by compiling the catalog number based on the design of the specific engineered heating unit required for your application. Typically, an engineered heating unit is designed using our TraceCalc Pro design software which provides the catalog number as part of the design output. An explanation of the catalog number follows.

Example: Engineered Heating Unit (Part No.: GEHU)

GEHU: E/32SA2200/40/538/208/5-7/S25A/X/NG/T8-10/RKFM

E / 32SA2200 / 40 / 538 / 208 / 5 - 7 / S25A / X / NG / T8-10 / RKFM

Position: 1 / 2 / 3 / 4 / 5 / 6 / 7 / 8 / 9 / 10 / 11

Position	Characteristic	Code options	Description
1	Design Configuration ⁶	A, B, D, or E	Designates the basic heating cable design configuration of the XMI engineered heating unit (XMI-L units available only in D and E configurations).
2	Heating cable reference	See XMI-A and XMI-L data sheets	Indicates the XMI-A or XMI-L heating cable reference used in the design. Refer to data sheets H56870 and H59079.
3	Heated length	Length of the heated section in feet or meters	Default value is in feet; if in meters add "M" after the length.
4	Power	Power output of the heating unit	Power output at maintain temperature, in Watts, for the total heated length of the engineered heating unit.
5	Voltage	Effective voltage applied to unit	This is the designed effective voltage that will be applied to the engineered heating unit (in the case of series connected heating units, it is the voltage across a single unit).

Position	Characteristic	Code options	Description
6	MI cold lead length	Length of the MI cold lead in feet or meters (End A length) or (End A length)– (End B length)	Default value is in feet; if in meters add “M” after the length. Standard MI cold lead length is 5 feet (1.5 m) for units with PyroFLX cold leads, however, custom lengths can be designated here. For E and B configurations, which have cold leads on each end, a single value (such as “5”) indicates that both MI cold leads are to be 5 feet long. A hyphenated value (such as “5-7”) indicates that the cold lead on one end (End A) is 5 feet long and the cold lead on the other end (End B) is 7 feet long. Note that when specifying quick connectors for E and B configurations with two different cold lead lengths (such as “5-7”), the first number (5) is the length for End A and the second number (7) is the length for End B. This nomenclature ensures that the correct connector is installed on the correct length of cold lead.
7	MI cold lead code	Select the cold lead code from Table 2	Table 2 is used to select the appropriate MI cold lead based on the current and voltage rating required by the design.
8	Hot-cold joint type	X or C	“X” type joint is used with all XMI-A engineered heating units. “C” type joint is used with all XMI-L engineered heating units.
9	Gland size reference	NG	For PyroFLX cold leads, gland size default is “NG” (no gland)
10	Type TC flexible tray cable length	Length of the tray cable in feet or meters T(End A length) or T(End A length)– T(End B length)	Default value is in feet; if in meters add “M” after the length. Standard lengths for flexible tray cable is 3 feet (0.9 m), however, custom lengths can be designated here. For E and B configurations, which have cold leads on each end, a single value (such as “T3”) indicates that the flexible tray cable on both ends is 3 feet long. A hyphenated value (such as “T3-T7”) indicates that the flexible tray cable on one end (End A) is 3 feet long and the flexible tray cable on the other end (End B) is 7 feet long. Note that when specifying Type K quick connectors for E and B configurations with two different flexible tray cable lengths (such as “T3-T7”), the first number (3) is the length for End A and the second number (7) is the length for End B. This nomenclature ensures that the correct connector is installed on the correct length of tray cable.
11	Connector options ⁷	RNN - Nothing/Nothing	PyroFLX cold lead with no connector on End A and no connector on End B Position 11 in the EHU catalog number for a PyroFLX cold lead with Type K connectors consists of four letters. The first letter (R) indicates the PyroFLX cold lead, the second letter (K) indicates Type K connector, the third letter (M, P, or N) is the connector option for End A and the fourth letter (M, F, or N) is the connector option for End B.
		RKMN - Male/Nothing	PyroFLX cold lead with a Male connector on End A and no connector on End B
		RKNF - Nothing/Female	PyroFLX cold lead with no connector on End A and a Female connector on End B
		RKMF - Male/Female	PyroFLX cold lead with a Male connector on End A and a Female connector on End B
		RKPF - Power/Female	PyroFLX cold lead with a Power connector on End A and a Female connector on End B
		RKPN - Power/Nothing	PyroFLX cold lead with a Power connector on End A and no connector on End B
		RKMM - Male/Male	PyroFLX cold lead with a Male connector on End A and a Male connector on End B

⁶ Since Design A and Design D units only have a single cold lead, End B will always be “nothing” (i.e. no connector).

⁷ A Power connector consists of both a Female and a Male connector (the Male connector is attached to the cold lead; the Female connector will be connected to the power supply at the job site).

HEATING UNIT OPTIONS USING PYROFLX COLD LEADS AND TYPE K QUICK CONNECTOR

**Design A (Single conductor)
Design D (Dual conductor)**

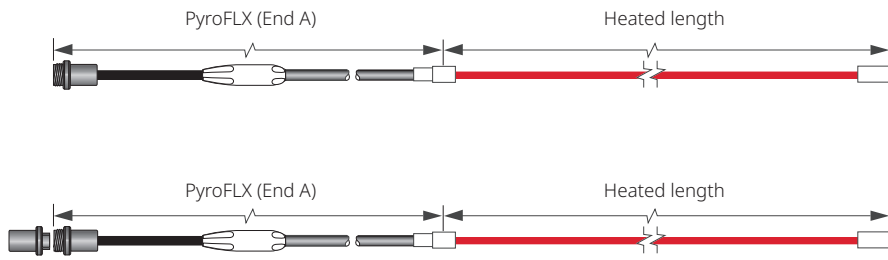

RKMN - Male/Nothing (PyroFLX cold lead with a Male connector on End A)

RKPN - Power/Nothing (PyroFLX cold lead with a Power connector on End A)

Note: D design configuration shown

**Design B (Single conductor)
Design E (Dual conductor)**

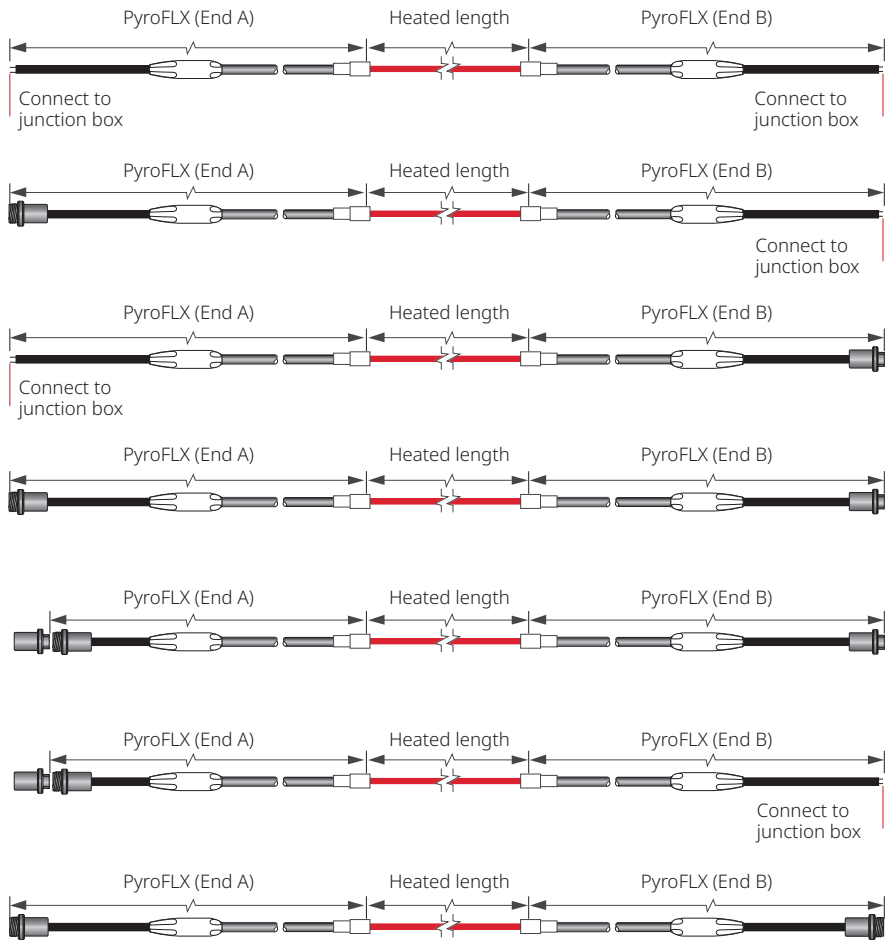

RNN - Nothing/Nothing (PyroFLX cold lead with no connector on End A and no connector on End B)

RKMN - Male/Nothing (PyroFLX cold lead with a Male connector on End A and no connector on End B)

RKNF - Nothing/Female (PyroFLX cold lead with no connector on End A and a Female connector on End B)

RKMF - Male/Female (PyroFLX cold lead with a Male connector on End A and a Female connector on End B)

RKPF - Power/Female (PyroFLX cold lead with a Power connector on End A and a Female connector on End B)

RKPN - Power/Nothing (PyroFLX cold lead with a Power connector on End A and no connector on End B)

RKMM - Male/Male (PyroFLX cold lead with a Male connector on End A and a Male connector on End B)

Note: E design configuration shown

D/62SQ3100/200/9920/480/5/S25A/X/NG/T3/RKMN

- Configuration is Design D
- XMI-A62 heating cable (600 V rated, dual conductor cable), resistance at 20°C is 0.100 Ω/ft (0.328 Ω/m)
- Heating cable length is 200 ft (61 m)
- Heating cable wattage is 9920 W at 480 V
- MI cold lead length is 5 ft (1.5 m) on End A
- MI cold lead code is S25A (25 Amps)
- Hot-cold joint type is "X" for use with XMI-A Alloy 825 sheath cables
- Gland connector is NG (no gland)
- Flexible tray cable is 3 ft (0.9 m) on End A
- Type K Male connector on End A

E/32SQ3200/25M/840/120/1.5M/LS23A/X/NG/T2.4-3.0M/RKPF

- Configuration is Design E
- XMI-A32 heating cable (300 V rated, dual conductor cable), resistance at 20°C is 0.200 Ω/ft (0.656 Ω/m)
- Heating cable length is 25 m (82 ft)
- Heating cable wattage is 840 W at 120 V
- MI cold lead length is 1.5 m (5 ft) on both End A and End B
- MI cold lead code is LS23A (23 Amps)
- Hot-cold joint type is "X" for use with XMI-A Alloy 825 sheath cables
- Gland connector is NG (no gland)
- Flexible tray cable is 2.4 m (8 ft) on End A and 3 m (10 ft) long on End B
- Type K Power connector on End A and Female connector on End B

B/61SQ3118/250/6820/480/5-7/S29A/X/NG/T8/RKMF

- Configuration is Design B
- XMI-A61 heating cable (600 V rated, single conductor cable), resistance at 20°C is 0.118 Ω/ft (0.387 Ω/m)
- Heating cable length is 250 ft (76 m)
- Heating cable wattage is 6820 W at 480 V
- MI cold lead length is 5 ft (1.5 m) on End A and 7 ft (2.1 m) on End B
- MI cold lead code is S29A (29 Amps)
- Hot-cold joint type is "X" for use with XMI-A Alloy 825 sheath cables
- Gland connector is NG (no gland)
- Flexible tray cable is 8 ft (2.4 m) on both End A and End B
- Type K Male connector on End A and Female connector on End B

TABLE 2 MI COLD LEAD CODES FOR USE WITH PYROFLX COLD LEADS AND TYPE K QUICK CONNECTORS

Due to current rating limitations, only the standard MI cold lead codes shown in Table 2 may be used with PyroFLX cold leads and Type K connectors. The PyroFLX cold lead is supplied from the factory with no quick connectors or with one or more quick connectors assembled to the cold lead.

Cold lead code	Maximum voltage (V)	Maximum current (A)	Cold lead diameter		Gland size reference	Tray cable tail size (AWG) ⁸
			(in)	(mm)		
Design A, D, E						
LS23A	300	23	0.319	8.1	NG	10
S25A	600	25	0.355	9.0	NG	10
S34A	600	30	0.402	10.2	NG	10
Design B						
S29A	600	29	0.215	5.5	NG	10
S48A	600	30	0.253	6.4	NG	10

Note: MI cold lead minimum bending radius is 6 times the cable diameter.

⁸ Tail size applies to cold leads without quick connectors (i.e. tray cable tails).

OTHER COLD LEAD OPTIONS

In addition, a heating cable can be terminated with a PyroFLX cold lead and Type K connector (or no connector) on one end and a mineral insulated cold lead and Type X connector on the other end as shown in the example below. For additional information on other options that are available for MI cold leads, contact your Chemelex representative or call (800) 545-6258.

GEHU: E/32SQ3200/82/840/120/5-2/LS23A/X/N12/T15.0-0.0/RNXF

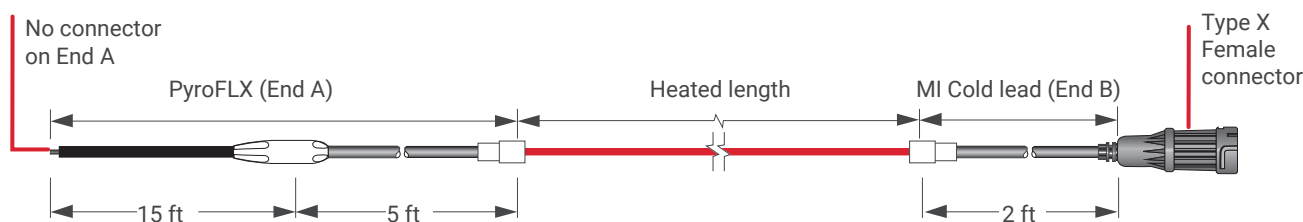

RNXF - PyroFLX cold lead with no connector on End A and MI cold lead with Type X Female connector on End B

GROUND-FAULT PROTECTION

To minimize the danger of fire from sustained electrical arcing if the heating cable is damaged or improperly installed, and to comply with the requirements of Chemelex, agency certifications, and national electrical codes, ground-fault equipment protection must be used on each heating cable branch circuit. Arcing may not be stopped by conventional circuit protection. Many Raychem control and monitoring systems meet the ground-fault protection requirement.

North America

Tel +1 800 545 6258
info@chemelex.com

Latin America

Tel +1 713 868 4800
info@chemelex.com

Europe, Middle East, Africa, India

Tel +32 16 213 511
Fax +32 16 213 604
info@chemelex.com

Asia Pacific

Tel +86 21 2412 1688
infoAPAC@chemelex.com